











	
<p>Art. 42/01 H.80xL.45mm</p>	<p>Art. 42/02 H.80xL.45mm</p>	<p>Art. 42/03 H.75xL.70mm</p>	<p>Art. 42/04 H.75xL.70mm</p>	
				
<p>Art. 42/05 H.165xL.70mm</p>	<p>Art. 42/06 H.165xL.70mm</p>	<p>Art. 42/07 H.225xL.130mm</p>	<p>Art. 42/08 H.225xL.130mm</p>	
				
<p>Art. 42/09 H.125xL.75mm</p>	<p>Art. 42/10 H.125xL.75mm</p>	<p>Art. 42/11 H.125xL.75mm</p>	<p>Art. 42/12 H.120xL.50mm</p>	<p>Art. 42/13 H.120xL.50mm</p>
				
<p>Art. 42/14 H.120xL.90mm</p>	<p>Art. 42/15 H.120xL.90mm</p>	<p>Art. 42/16 H.120xL.90mm</p>	<p>Art. 42/17 H.120xL.90mm</p>	

Art. 43/01 H.280xL.190mm	Art. 43/02 H.280xL.190mm	Art. 43/03 H.280xL.230mm	Art. 43/04 H.280xL.230mm











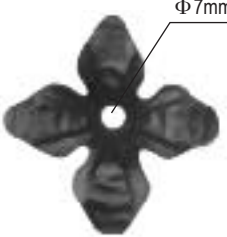
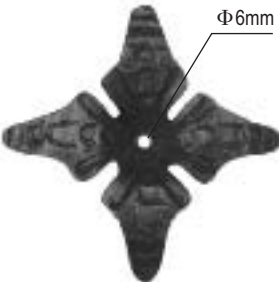

Art. 43/05 H.385xL.150mm	Art. 43/06 H.385xL.150mm	Art. 43/07 H.450xL.160mm	Art. 43/08 H.450xL.160mm

Art. 43/09 H.100xL.50mm	Art. 43/10 H.65xL.45mm	Art. 43/11 H.90xL.90mm	Art. 43/12 Φ85mm

Art. 43/13 H.45xL.40mm	Art. 43/14 H.95xL.80mm	Art. 43/15 H.75xL.90mm	Art. 43/16 H.75xL.175mm

 	□20.5mm Art. 43/17A H.110xL.125mm Art. 43/17B H.95xL.110mm Art. 43/17C H.80xL.95mm Art. 43/17D H.70xL.75mm					
	Art. 43/18A	Art. 43/18B	Art. 43/19	Art. 43/20		
	Φ70mm	Φ90mm	H.90xL.140mm	H.75xL.90mm		

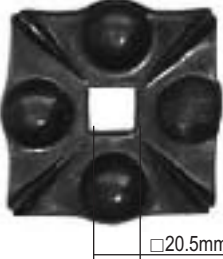
 <p>Art. 44/01</p>	 <p>Art. 44/02</p>	 <p>Art. 44/03</p>	 <p>Art. 44/04</p>	
<p>H.140xL.105mm □16mm</p>	<p>H.140xL.105mm Φ 16mm</p>	<p>H.160xL.200mm</p>	<p>H.290xL.85mm</p>	
 <p>Art. 44/05</p>	 <p>Art. 44/06</p>	 <p>Art. 44/07</p>	 <p>Art. 44/08</p>	 <p>Art. 44/09</p>
<p>H.160xL.160mm</p>	<p>H.200xL.100mm</p>	<p>H.240xL.50mm</p>	<p>H.230xL.45mm</p>	<p>H.300 Φ 12mm</p>
 <p>Art. 44/10</p>		 <p>Art. 44/11</p>		 <p>Art. 44/12</p>
<p>H.245xL.480mm</p>		<p>H.310xL.600mm</p>		<p>H.390xL.305mm</p>
 <p>Art. 44/13</p>	 <p>Art. 44/14</p>	 <p>Art. 44/15</p>		
<p>H.395xL.370mm</p>	<p>H.400xL.430mm</p>	<p>H.475xL.430mm</p>		

 <p>Art. 45/01A Φ50mm $\delta \neq 12$ Art. 45/01B Φ90mm $\delta \neq 12$ Art. 45/01C Φ125mm $\delta \neq 12$</p>	 <p>Art. 45/02A Φ70mm $\delta \neq 12$ Art. 45/02B Φ100mm $\delta \neq 12$</p>	 <p>Art. 45/03 Φ95mm $\delta \neq 3$</p>	 <p>Φ12mm Art. 45/04 Φ67mm $\delta \neq 8$</p>
 <p>Φ12mm Art. 45/05 Φ65mm $\delta \neq 8$</p>	 <p>Φ7mm Art. 45/06 Φ68mm $\delta \neq 2$</p>	 <p>Φ6mm Art. 45/07 Φ130mm $\delta \neq 4$</p>	 <p>Art. 45/08A Φ80mm $\delta \neq 2.5$ Art. 45/08B Φ120mm $\delta \neq 2.5$</p>
 <p>Φ7mm Art. 45/09 Φ90mm $\delta \neq 4$</p>	 <p>Art. 45/10 Φ90mm</p>	 <p>Φ6mm Art. 45/11 Φ120mm $\delta \neq 4$</p>	 <p>Art. 45/12 Φ120mm</p>
 <p>Art. 45/13 Φ100mm $\delta \neq 4$</p>	 <p>\square20.5mm Art. 45/14 L.105xW.105mm $\delta \neq 8$</p>	 <p>Art. 45/15 H.182.5xW.98mm $\delta \neq 3.5$</p>	 <p>Φ32mm Art. 45/16 H.200xΦ130mm</p>



Art. 46/01

H.190xL.70mm $\delta \neq 2.5$



Art. 46/02

H.160xL.40mm $\delta \neq 2.5$



Art. 46/03

H.160xL.40mm $\delta \neq 2.5$



Art. 46/04

H.335xL.120mm $\delta \neq 2.5$



Art. 46/05

H.280xL.50mm $\delta \neq 2.5$



Art. 46/06

H.280xL.50mm $\delta \neq 2.5$



Art. 46/07

H.300xL.40mm $\delta \neq 2$



Art. 46/08

H.195xL.99mm



Art. 46/09

H.270mm Φ 6mm



Art. 46/10

H.270mm Φ 6mm



Art. 46/11

L.104xW.40mm $\delta \neq 3$

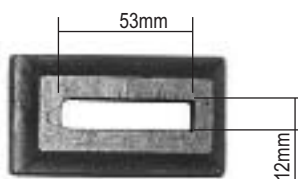

Art. 46/12

L.87xW.48xH.26mm $\delta = 4$

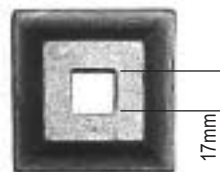

Art. 46/13

L.91xW.91xH.24mm $\delta = 4$

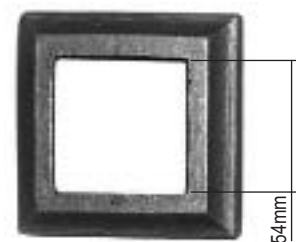

Art. 46/14

L.66xW.66xH.20mm $\delta = 4$



Art. 47/01

H.170xL.110mm Φ 10mm

Art. 47/02

H.170xL.110mm Φ 10mm

Art. 47/03

H.270xL.190mm Φ 10mm

Art. 47/04

H.270xL.190mm Φ 10mm

Art. 47/05

H.370xL.330mm Φ 12mm

Art. 47/06

H.370xL.330mm Φ 12mm

Art. 47/07

H.490xL.305mm Φ 12mm

Art. 47/08

H.490xL.305mm Φ 12mm

Art. 47/09

H.620xL.410mm Φ 12mm

Art. 47/10

H.620xL.410mm Φ 12mm

Art. 47/11

H.660xL.270mm Φ 12mm

Art. 47/12

H.660xL.270mm Φ 12mm



Art. 48/01

H.800xL.480mm Φ 12mm



Art. 48/02

H.800xL.480mm Φ 12mm



Art. 48/03

H.970xL.420mm Φ 12mm



Art. 48/04

H.970xL.420mm Φ 12mm



Art. 48/05

H.410xL.470mm Φ 6mm

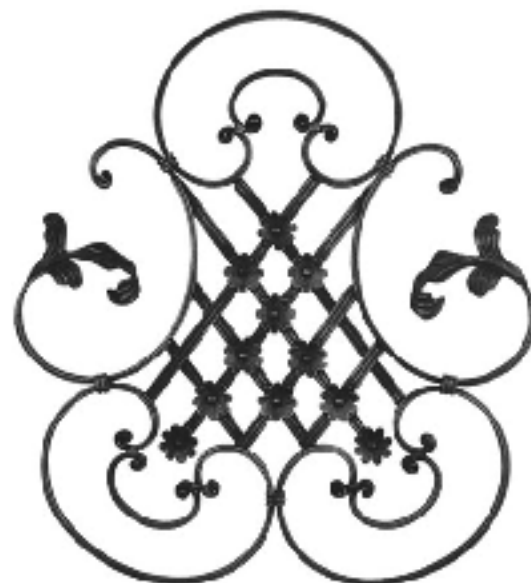

Art. 48/06

H.710xL.650mm 16x8mm

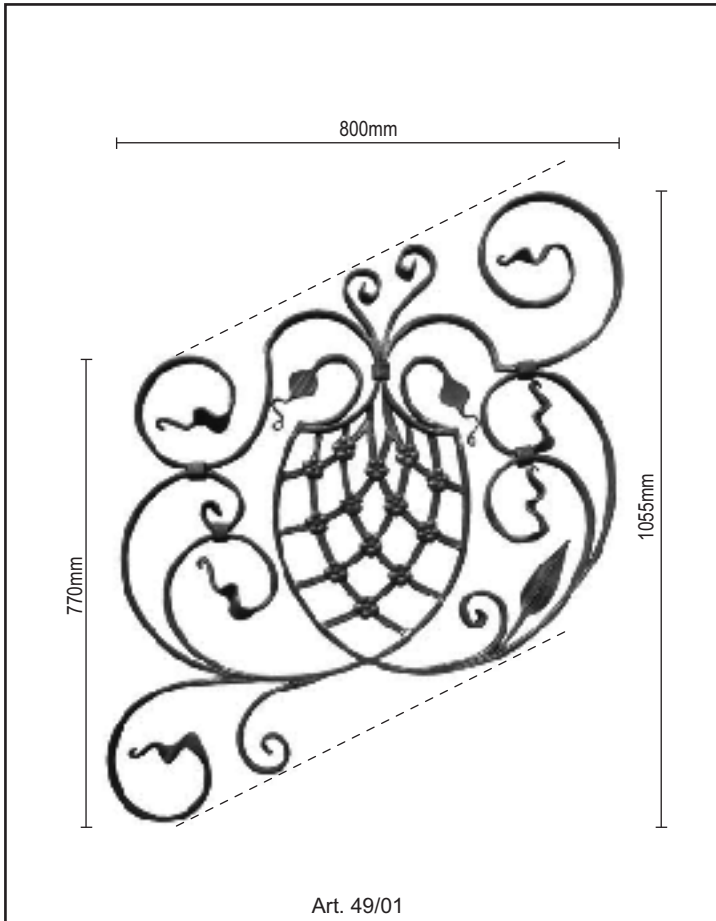

Art. 49/01

H.1055xL.800mm 25x8mm

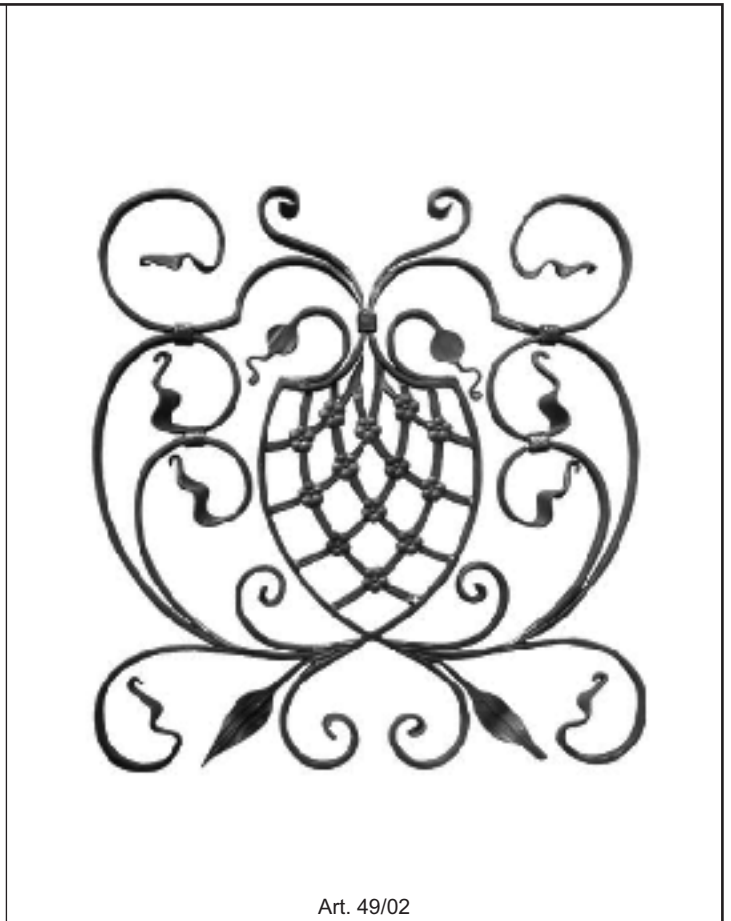

Art. 49/02

H.855xL.800mm 25x8mm

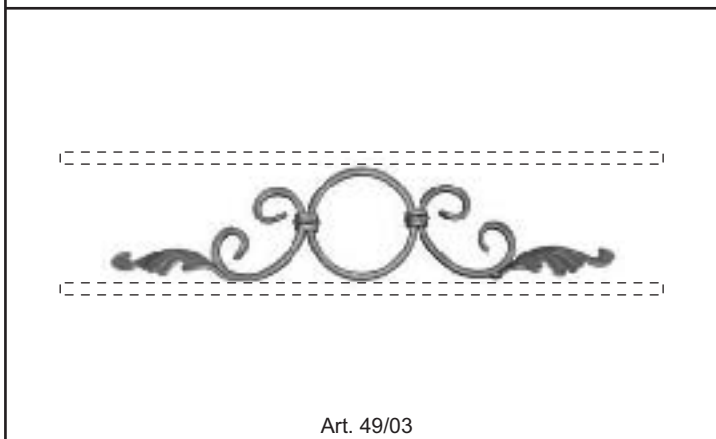

Art. 49/03

H.100xL.445mm 12x6mm

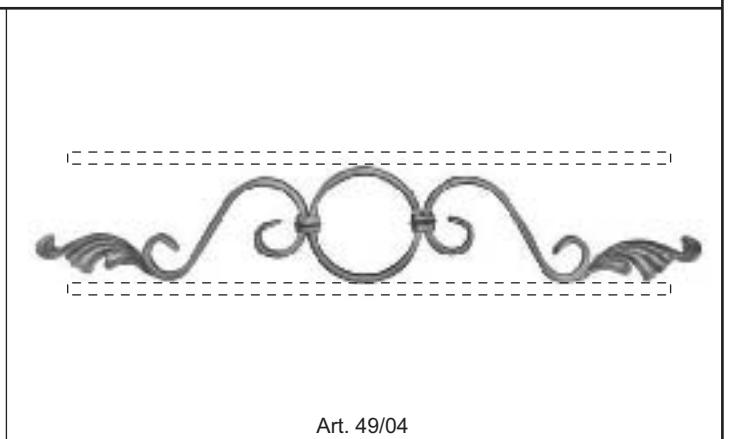

Art. 49/04

H.100xL.595mm 12x6mm

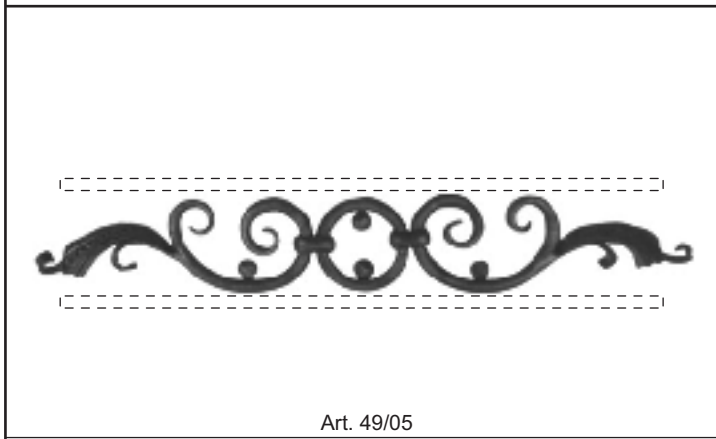

Art. 49/05

H.80xL.525mm Φ 12mm

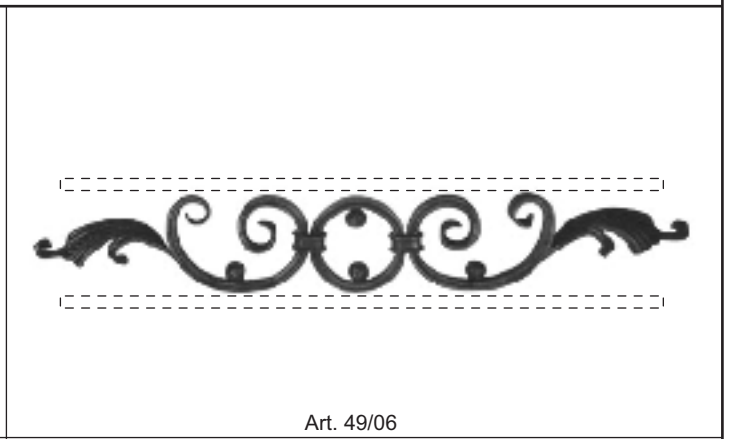

Art. 49/06

H.80xL.525mm 16x8mm



Art.50/01

H.1060xL.740mm Φ 12mm



Art.50/02

H.1060xL.740mm Φ 12mm



Art.50/03

H.880xL.800mm Φ 12mm



Art.50/04

H.880xL.800mm Φ 12mm



Art.51/01

H.880xL.580mm Φ 12mm

Art.51/02

H.880xL.580mm Φ 12mm

Art.51/03

H.970xL.780mm Φ 12mm

Art.51/04

H.970xL.780mm Φ 12mm

Art.51/05

H.330xL.1000mm \square 12mm

Art.51/06

H.250xL.142mm 12x6mm



H.225xL.760mm
 Art. 52/01A 14x6mm
 Art. 52/01B 20x6mm



Art.52/05
 H.170xL.255mm 16x6mm



H.330xL.1100mm
 Art. 52/02A 14x6mm
 Art. 52/02B 20x6mm



Art.52/06
 H.285xL.435mm 16x6mm



H.225xL.800mm
 Art. 52/03A 14x6mm
 Art. 52/03B 20x6mm

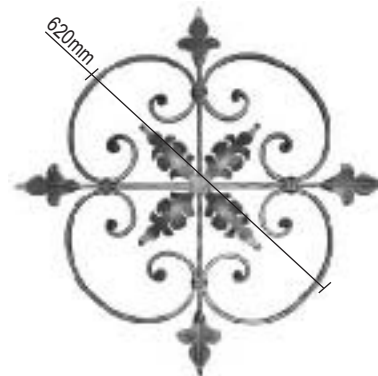

Art.52/07
 H.750xL.750mm 16x8mm



Art.52/04
 H.190xL.960mm 14x6mm

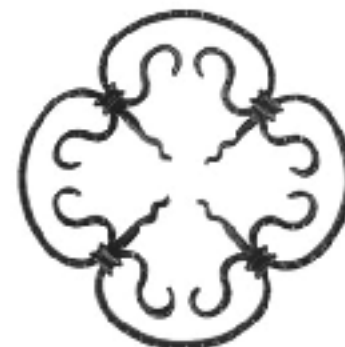

Art.52/08
 H.240xL.240mm 14x6mm



Art. 53/01

H.830xL.270mm □12mm



Art. 53/02

H.880xL.270mm □12mm



Art. 53/03

H.780xL.270mm □12mm



Art. 53/04

H.810xL.270mm □12mm



Art. 53/05

H.800xL.280mm □8mm



Art. 53/06

H.870xL.320mm 12x6mm



Art. 53/07

H.880xL.350mm 16x8mm



Art. 53/08

H.900xL.340mm Φ14mm

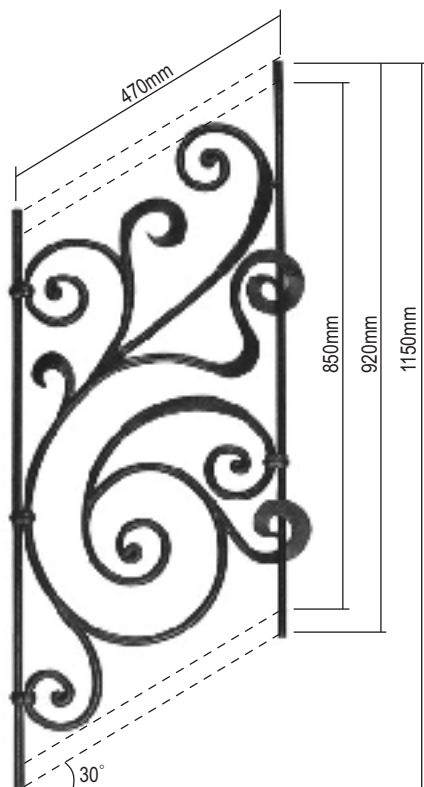

Art. 54/01

H.1150xL.420mm ϕ 14mm

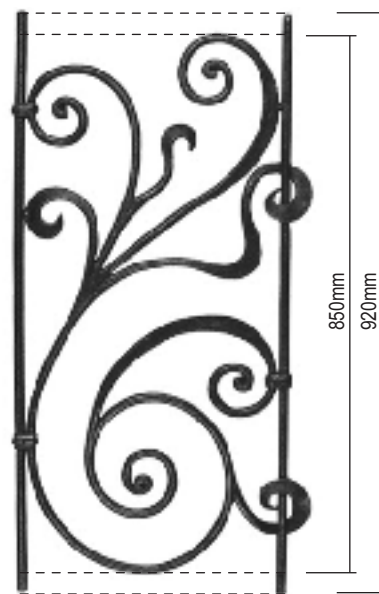

Art. 54/02

H.920xL.420mm ϕ 14mm



Art. 54/03

Φ 250mm / \square 8mm



Art. 54/04

Φ 250mm / \square 8mm



Art. 54/05

H120mm \square 8mm



Art. 54/06

H120mm \square 8mm



Art. 54/07

Φ 294mm / Φ 12mm



Art. 54/08

Φ 294mm / Φ 12mm



Art. 54/09

Φ 294mm / \square 12mm



Φ 600mm

Art. 55/01A □ 14mm

Art. 55/01B □ 16mm



Φ 600mm

Art. 55/02A □ 14mm

Art. 55/02B □ 16mm



Art.55/03

Φ 560mm 14x8mm



Art.55/04

H.400xL.380mm Φ 14mm



Art. 56/01
Φ 14x1000mm



Art. 56/02
Φ 14x1000mm



Art. 56/03
Φ 14x1000mm



Art. 56/04
Φ 14x1000mm



Art. 56/05
H.900xL.165mm Φ 14mm



Art. 56/06
H.950xL.215mm Φ 14mm



Art. 56/07
H.900xL.400mm Φ 10mm

Art. 56/07A
H.900xL.370mm Φ 12mm



Art. 56/08
H.234xL.138mm



Art. 56/09
H.200xL.85mm



Art. 56/10
H.160xL.100mm



Art. 56/11
H.245xL.138mm



Art. 56/12
H.170xL.80mm



Art. 56/13
H.270xL.76mm



Art. 56/14
Φ 18xH.30mm



Art. 56/15
Φ 20xH.50mm



Art. 56/16
Φ 14xH.30mm



Art. 56/17
Φ 20xH.40mm



Art. 57/01

Art. 57/02

Art. 57/03

Art. 57/04

Art. 57/05

Art. 57/06

Φ 12x1000mm

Φ 12x1000mm

Φ 12x1000mm

Φ 12x1000mm

Φ 12x1000mm

Φ 12x1000mm

Art. 57/01A

Art. 57/02A

Art. 57/03A

Art. 57/04A

Art. 57/05A

Art. 57/06A

Φ 14x1000mm

Φ 14x1000mm

Φ 14x1000mm

Φ 14x1000mm

Φ 14x1000mm

Φ 14x1000mm



Art. 57/07

Art. 57/08

Art. 57/09

Art. 57/10

Art. 57/11

Φ 12x1000mm

Φ 12x1000mm

Φ 12x1000mm

Φ 12x1000mm

Φ 12x1000mm

Art. 57/07A

Art. 57/08A

Art. 57/09A

Art. 57/10A

Art. 57/11A

Φ 14x1000mm

Φ 14x1000mm

Φ 14x1000mm

Φ 14x1000mm

Φ 14x1000mm

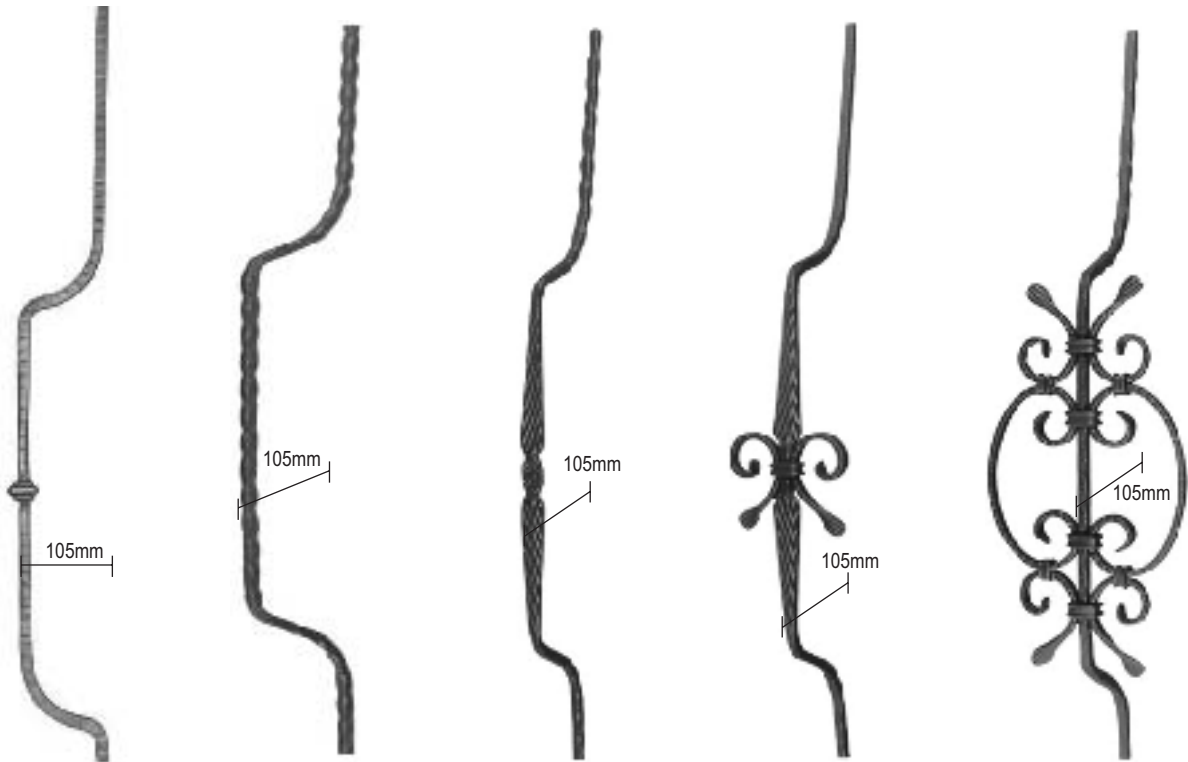

Art. 58/01

Art. 58/02

Art. 58/03

Art. 58/04

Art. 58/05

12x1000mm

12x1000mm

12x1000mm

12x1000mm

12x1000mm

Art. 58/01A

Art. 58/02A

Art. 58/03A

Art. 58/04A

Art. 58/05A

14x1000mm

14x1000mm

14x1000mm

14x1000mm

14x1000mm

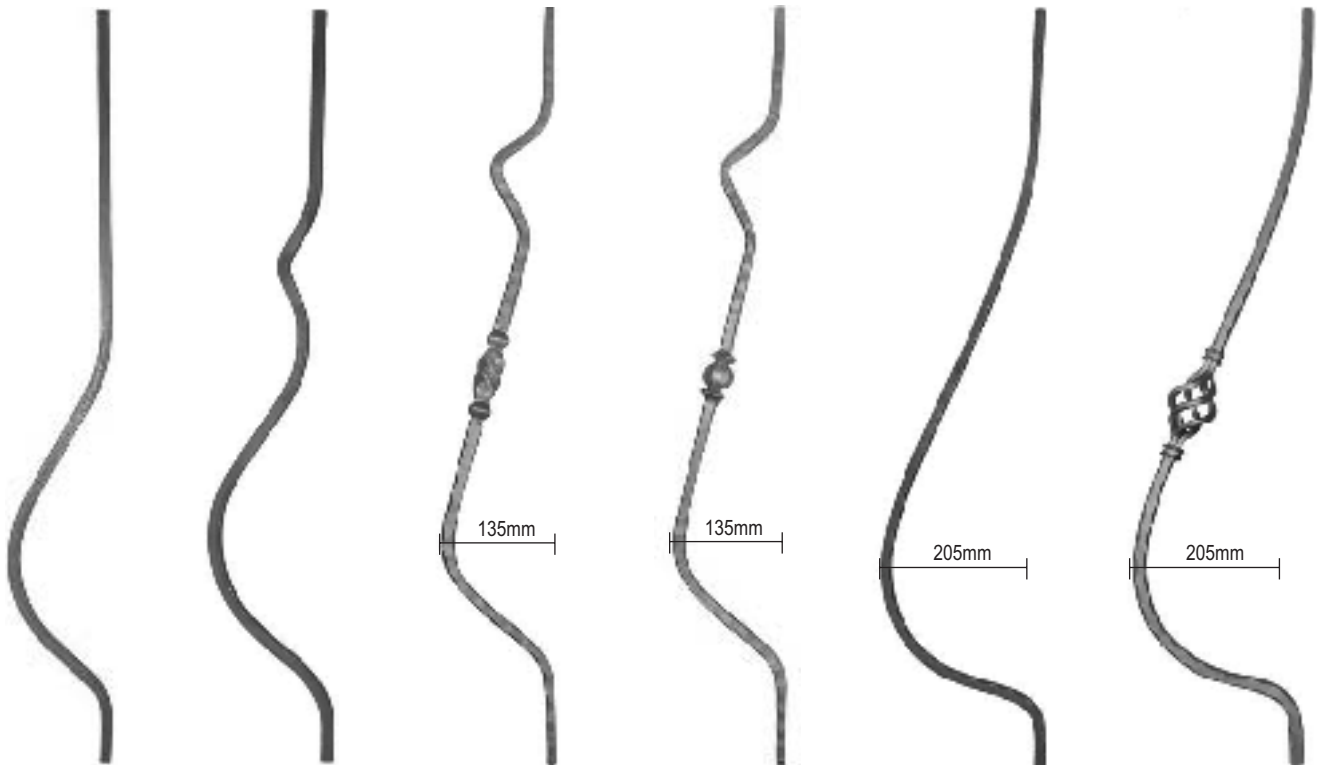

Art. 58/06

Art. 58/07

Art. 58/08

Art. 58/09

Art. 58/10

Art. 58/11

12x1000mm

12x1000mm

12x1000mm

12x1000mm

12x1000mm

12x1000mm

Art. 58/06A

Art. 58/07A

Art. 58/08A

Art. 58/09A

Art. 58/10A

Art. 58/11A

14x1000mm

14x1000mm

14x1000mm

14x1000mm

14x1000mm

14x1000mm



Art. 59/01

□ 12x1000mm

Art. 59/02

□ 12x1000mm

Art. 59/03

Φ 12x1000mm

Art. 59/04

Φ 12x1000mm

Art. 59/05

□ 12x1000mm

Art. 59/06

□ 12x1000mm

Art. 59/07

□ 12x1000mm

Art. 59/08

□ 12x1000mm

Art. 59/01A

□ 14x1000mm

Art. 59/02A

□ 14x1000mm

Art. 59/03A

Φ 14x1000mm

Art. 59/04A

Φ 14x1000mm

Art. 59/05A

□ 14x1000mm

Art. 59/06A

□ 14x1000mm

Art. 59/07A

□ 14x1000mm

Art. 59/08A

□ 14x1000mm



Art. 59/09

□ 12x1000mm

Art. 59/10

□ 12x1000mm

Art. 59/11

Φ 12x1000mm

Art. 59/12

Φ 12x1000mm

Art. 59/13

□ 12x1000mm

Art. 59/14

□ 12x1000mm

Art. 59/15

□ 12x1000mm

Art. 59/16

□ 12x1000mm

Art. 59/09A

□ 14x1000mm

Art. 59/10A

□ 14x1000mm

Art. 59/11A

Φ 14x1000mm

Art. 59/12A

Φ 14x1000mm

Art. 59/13A

□ 14x1000mm

Art. 59/14A

□ 14x1000mm

Art. 59/15A

□ 14x1000mm

Art. 59/16A

□ 14x1000mm



Art. 61/01

□ 12x1000mm

Art. 61/01A

□ 14x1000mm



Art. 61/02

□ 12x1000mm

Art. 61/02A

□ 14x1000mm



Art. 61/03

□ 12x1000mm

Art. 61/03A

□ 14x1000mm



Art. 61/04

□ 12x1000mm

Art. 61/04A

□ 14x1000mm



Art. 61/05

□ 12x1000mm

Art. 61/05A

□ 14x1000mm



Art. 61/06

□ 12x1000mm

Art. 61/06A

□ 14x1000mm



Art. 61/07

□ 12x1000mm

Art. 61/07A

□ 14x1000mm



Art. 61/08

□ 12x1000mm

Art. 61/08A

□ 14x1000mm



Art. 61/09

□ 12x1000mm

Art. 61/09A

□ 14x1000mm



Art. 61/10

□ 12x1000mm

Art. 61/10A

□ 14x1000mm



Art. 62/01
Φ 12x1000mm



Art. 62/02
Φ 12x1000mm



Art. 62/03
Φ 12x1000mm



Art. 62/04
Φ 12x1000mm



Art. 62/05
Φ 12x1000mm



Art. 62/06
H.900xL.145mm □8mm



Art. 62/07
Φ 25x1200mm



Art. 62/08
H.800xL.155mm □12mm



Art. 62/09
H.800xL.105mm □12mm



Art. 62/10
H.800xL.140mm 20x4mm



Art. 62/11
H.800xL.140mm 20x4mm



Art. 63/01

Art. 63/02

Art. 63/03

Art. 63/04

Art. 63/05

Art. 63/06

Art. 63/07

Art. 63/08

□ 12x1000mm

□ 12x1000mm

□ 12x1000mm

□ 12x1000mm

□ 12x1000mm

□ 12x1000mm

Φ 12x1000mm

Φ 12x1000mm

Art. 63/01A

Art. 63/02A

Art. 63/03A

Art. 63/04A

Art. 63/05A

Art. 63/06A

Art. 63/07A

Art. 63/08A

□ 14x1000mm

□ 14x1000mm

□ 14x1000mm

□ 14x1000mm

□ 14x1000mm

□ 14x1000mm

Φ 14x1000mm

Φ 14x1000mm

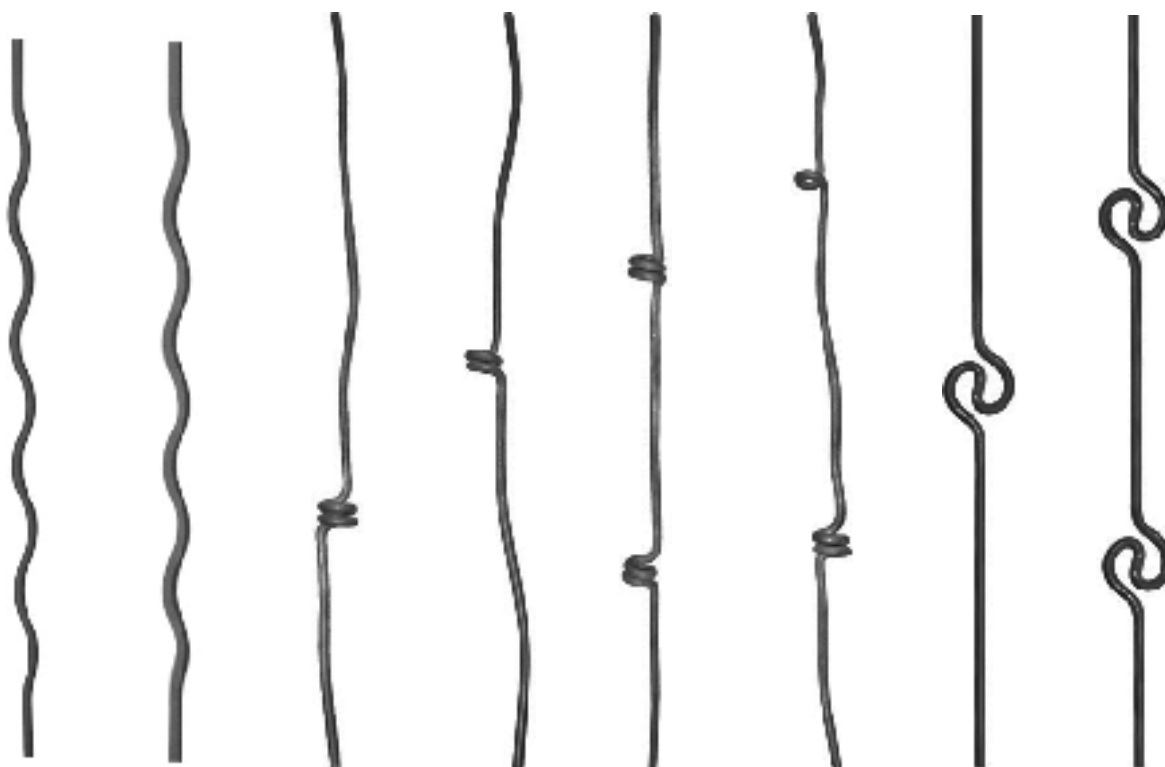

Art. 63/09

Art. 63/10

Art. 63/11

Art. 63/12

Art. 63/13

Art. 63/14

Art. 63/15

Art. 63/16

Φ 12x1000mm

□ 12x1000mm

Φ 12x1000mm

Φ 12x1000mm

Φ 12x1000mm

Φ 12x1000mm

Φ 12x1000mm

Φ 12x1000mm

Art. 63/09A

Art. 63/10A

Art. 63/11A

Art. 63/12A

Art. 63/13A

Art. 63/14A

Art. 63/15A

Art. 63/16A

Φ 14x1000mm

□ 14x1000mm

Φ 14x1000mm

Φ 14x1000mm

Φ 14x1000mm

Φ 14x1000mm

Φ 14x1000mm

Φ 14x1000mm



Art. 64/01	Art. 64/02	Art. 64/03	Art. 64/04	Art. 64/05	Art. 64/06	Art. 64/07	Art. 64/08
Φ 14x1000mm	Φ 14x1000mm	Φ 14x1000mm	□ 14x1000mm	□ 14x1000mm	Φ 14x1000mm	Φ 14x1000mm	□ 14x1000mm



Art. 64/09	Art. 64/10	Art. 64/11	Art. 64/12	Art. 64/13	Art. 64/14	Art. 64/15	Art. 64/16
□ 14x1000mm	□ 14x1000mm	□ 20x1200mm	□ 25x1200mm	□ 25x1200mm	Φ 25x1200mm	□ 25x1200mm	Φ 50x1300mm

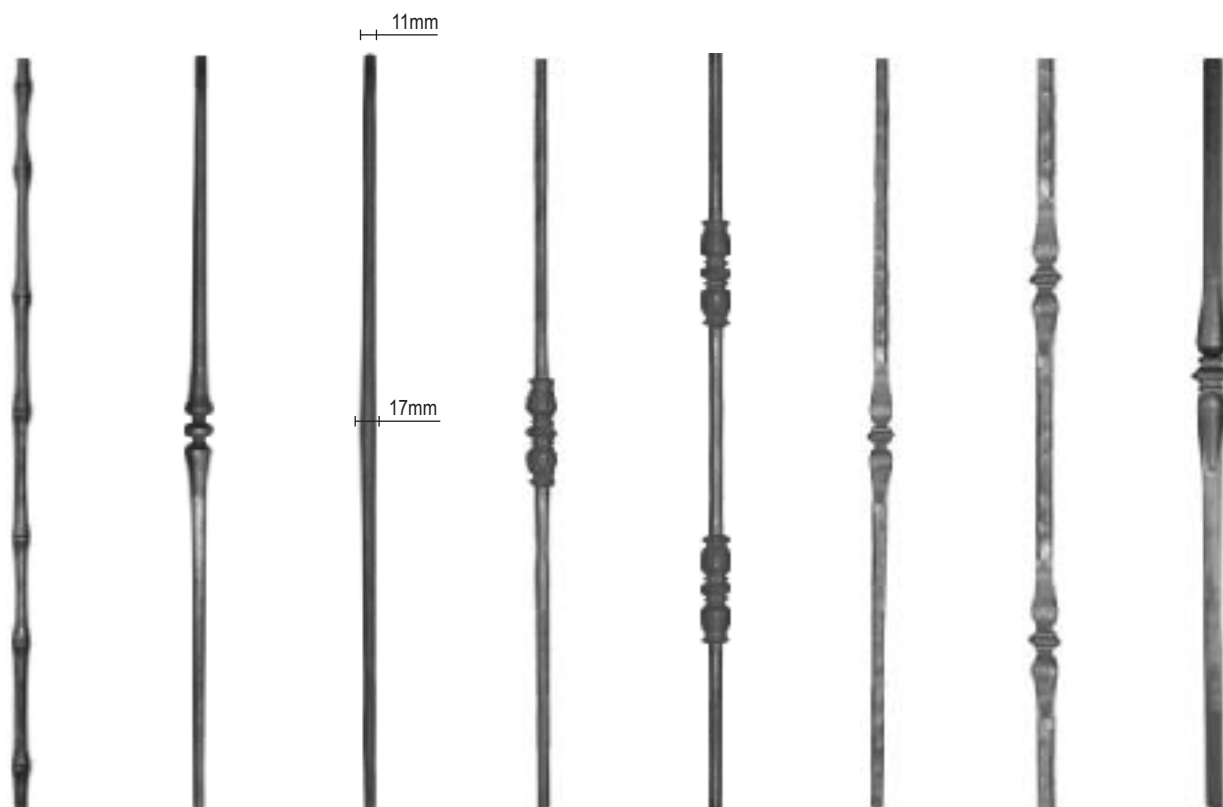

Art. 65/01

Art. 65/02

Art. 65/03

Art. 65/04

Art. 65/05

Art. 65/06

Art. 65/07

Art. 65/08

Φ 16x1000mm

Φ 14x1000mm

Φ 11x1000mm

Φ 12x1000mm

Φ 12x1000mm

□ 12x1000mm

□ 12x1000mm

□ 25x1200mm

Art. 65/01A

Art. 65/04A

Art. 65/05A

Art. 65/06A

Art. 65/07A

Φ 30x1000mm

Φ 14x1000mm

Φ 14x1000mm

□ 14x1000mm

□ 14x1000mm



Art. 65/09

Art. 65/10

Art. 65/11

Art. 65/12

Art. 65/13

Art. 65/14

Art. 65/15

Φ 20x1000mm

□ 25x1200mm

□ 14x1000mm

□ 14x1000mm

□ 25x1200mm





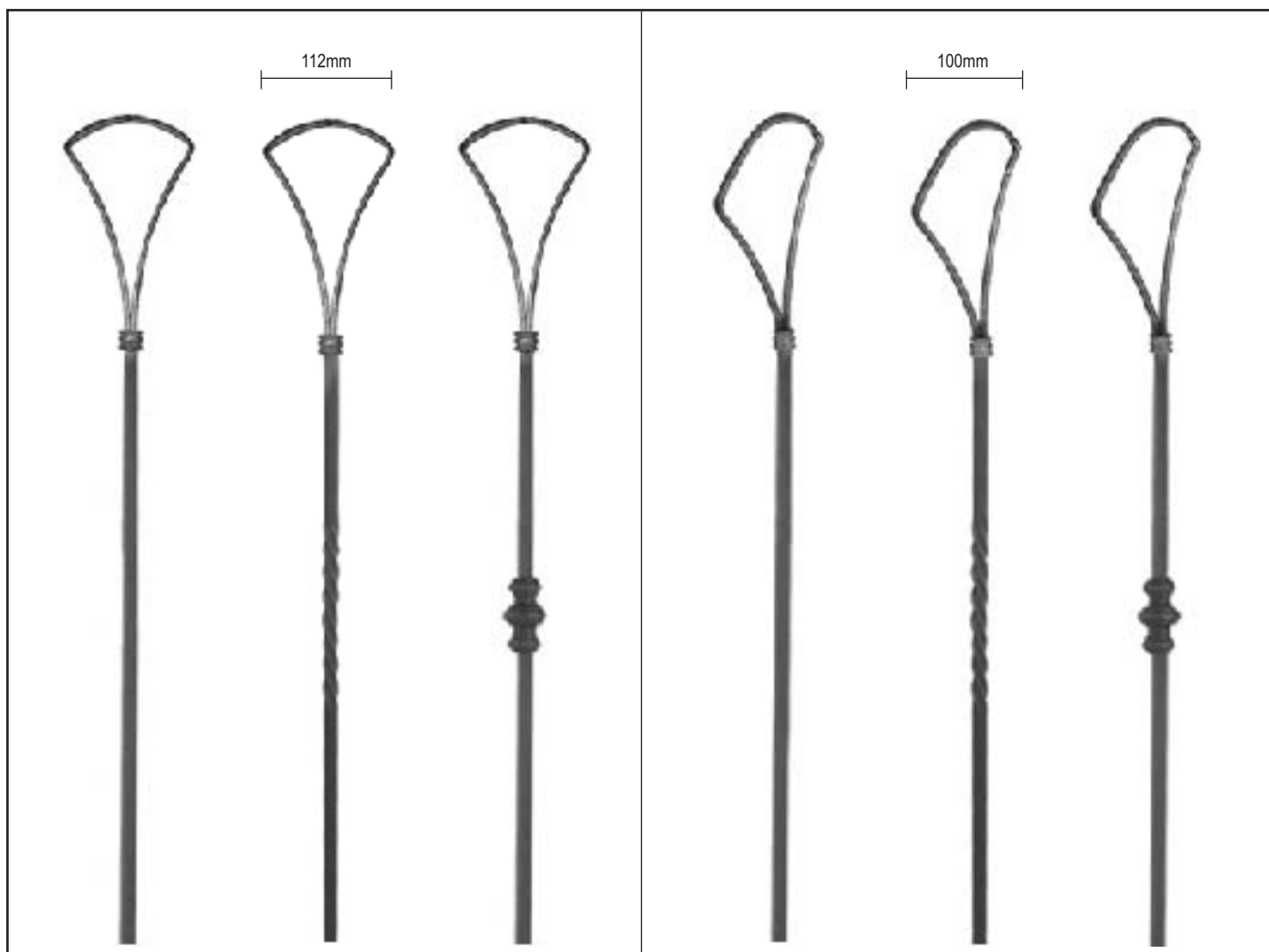



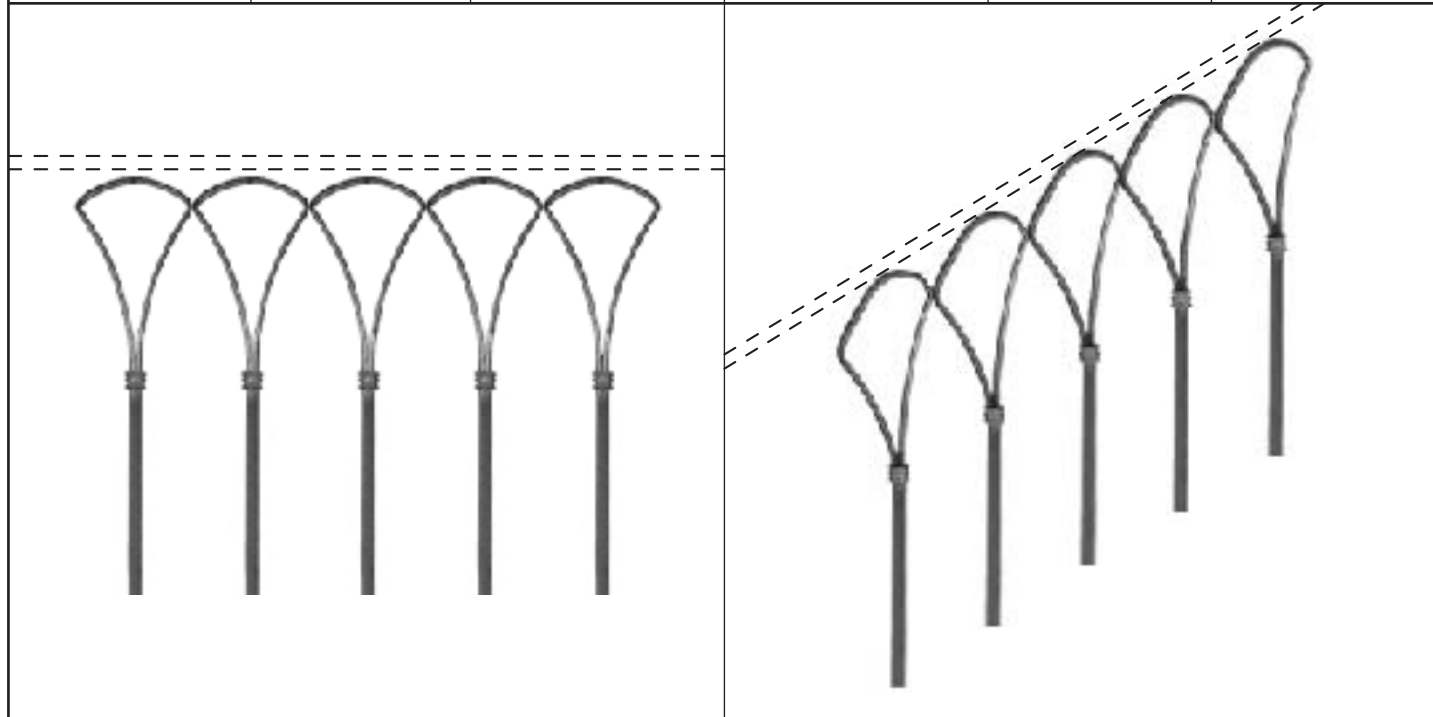











□ 25x1200mm











□ 12x1000mm







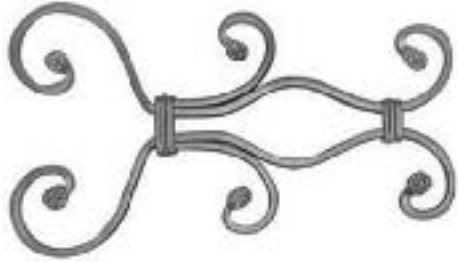
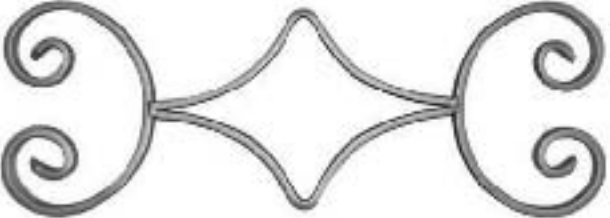

Art. 66/01	Art. 66/02	Art. 66/03	Art. 66/04	Art. 66/05	Art. 66/06
□ 12x1000mm	□ 12x1000mm	□ 12x1000mm	□ 12x1000mm	□ 12x1000mm	□ 12x1000mm







 <table border="1" data-bbox="225 344 435 465"> <tr> <td>16x10mm</td> </tr> <tr> <td>Art. 67/01 105x62mm</td> </tr> <tr> <td>Art. 67/02 105x70mm</td> </tr> <tr> <td>Art. 67/03 120x76mm</td> </tr> </table>	16x10mm	Art. 67/01 105x62mm	Art. 67/02 105x70mm	Art. 67/03 120x76mm	 <p>Art. 67/04</p> <p>H.120xL.73mm □8mm</p>	 <p>Art. 67/05</p> <p>H.170xL.90mm □16mm</p>	 <p>16x10mm</p> <p>Art. 67/06 H.70xL.105mm</p> <p>Art. 67/07 H.105xL.125mm</p>
16x10mm							
Art. 67/01 105x62mm							
Art. 67/02 105x70mm							
Art. 67/03 120x76mm							
 <p>Art. 67/08</p> <p>H.210xL.110mm 20x10mm</p>	 <p>Art. 67/09</p> <p>H.210xL.110mm 20x10mm</p>	 <p>Art. 67/10</p> <p>H.220xL.110mm 16x10mm</p>	 <p>Art. 67/11</p> <p>H.220xL.110mm 16x10mm</p>				
 <p>Art. 67/12</p> <p>H.180xL.80mm □8mm</p>	 <p>Art. 67/13</p> <p>H.220xL.110mm □8mm</p>	 <p>Art. 67/14</p> <p>H.290xL.110mm □8mm</p>	 <p>Art. 67/15</p> <p>H.360xL.110mm □8mm</p>				
 <p>Art. 67/16</p> <p>H.330xL.160mm □14mm</p>	 <p>Art. 67/17</p> <p>H.290xL.130mm 14x8mm</p>	 <p>H.360xL.120mm</p> <p>Art. 67/18 12x6mm</p> <p>Art. 67/19 14x6mm</p>	 <p>H.360xL.120mm</p> <p>Art. 67/20 12x6mm</p> <p>Art. 67/21 14x6mm</p>				
 <p>Art. 67/22</p> <p>H.100xL.200mm □16mm</p>	 <p>Art. 67/23</p> <p>H.40xL.70mm 16x8mm</p>	 <p>Art. 67/24</p> <p>H.70xL.140mm 16x8mm</p>	 <p>Art. 67/26</p> <p>H.215xL.210mm □14mm</p>				
 <p>Art. 67/25</p> <p>H.85xL.430mm 12x6mm</p>							



 <p>H.253xL.125mm</p>	 <p>H.253xL.125mm</p>	 <p>H.300xL.110mm</p>	
<p>Art. 68/01A 12x6mm</p>	<p>Art. 68/02A 12x6mm</p>	<p>Art. 68/03A 12x6mm</p>	
<p>Art. 68/01B 14x6mm</p>	<p>Art. 68/02B 14x6mm</p>	<p>Art. 68/03B 14x6mm</p>	
 <p>□16mm</p> <p>Art. 68/04A 100x290mm</p> <p>Art. 68/04B 100x350mm</p> <p>Art. 68/04C 140x430mm</p> <p>Art. 68/04D 140x620mm</p>		 <p>Art. 68/05</p> <p>H.140xL.420mm □16mm</p>	
 <p>Art. 68/06</p> <p>H.90xL.240mm 16x8mm</p>		 <p>Art. 68/07</p> <p>H.90xL.240mm 16x8mm</p>	
 <p>Art. 68/08</p> <p>H.130xL.300mm Φ12mm</p>		 <p>Art. 68/09</p> <p>H.200xL.345mm 12x6mm</p>	
 <p>Art. 68/10</p> <p>H.160xL.445mm 14x6mm</p>		 <p>Art. 68/11</p> <p>H.165xL.445mm 12x6mm</p>	

											
	12x6mm	14x6mm	16x6mm		12x6mm	14x6mm	16x6mm		12x6mm	14x6mm	16x6mm
Φ 100mm	Art. 69/01A	Art. 69/01B	Art. 69/01C	Φ 100mm	Art. 69/07A	Art. 69/07B	Art. 69/07C	Φ 100mm	Art. 69/13A	Art. 69/13B	Art. 69/13C
Φ 110mm	Art. 69/02A	Art. 69/02B	Art. 69/02C	Φ 110mm	Art. 69/08A	Art. 69/08B	Art. 69/08C	Φ 110mm	Art. 69/14A	Art. 69/14B	Art. 69/14C
Φ 115mm	Art. 69/03A	Art. 69/03B	Art. 69/03C	Φ 115mm	Art. 69/09A	Art. 69/09B	Art. 69/09C	Φ 115mm	Art. 69/15A	Art. 69/15B	Art. 69/15C
Φ 120mm	Art. 69/04A	Art. 69/04B	Art. 69/04C	Φ 120mm	Art. 69/10A	Art. 69/10B	Art. 69/10C	Φ 120mm	Art. 69/16A	Art. 69/16B	Art. 69/16C
Φ 125mm	Art. 69/05A	Art. 69/05B	Art. 69/05C	Φ 125mm	Art. 69/11A	Art. 69/11B	Art. 69/11C	Φ 125mm	Art. 69/17A	Art. 69/17B	Art. 69/17C
Φ 130mm	Art. 69/06A	Art. 69/06B	Art. 69/06C	Φ 130mm	Art. 69/12A	Art. 69/12B	Art. 69/12C	Φ 130mm	Art. 69/18A	Art. 69/18B	Art. 69/18C

			
Art. 69/19A	Art. 69/19B	Art. 69/19C	Art. 69/19D
Φ 100mm 16x8mm	Φ 100xL.165mm 16x8mm	Φ 100xL.230mm 16x8mm	Φ 100xL.295mm 16x8mm

			
Art. 69/20A	Art. 69/20B	Art. 69/20C	Art. 69/20D
Φ 100mm 12x6mm	Φ 100xL.165mm 12x6mm	Φ 100xL.230mm 12x6mm	Φ 100xL.295mm 12x6mm

Art. 69/21A
L.150mm 14x5mm

	
Art. 69/21B	Art. 69/21C
H.110xL.110mm 14x5mm	H.110xL.110mm 14x5mm

Art. 69/22
H.930xL.410mm □30mm

Art. 69/23
H.950xL.400mm □30mm



Art. 70/01
H.78xL.120mm



Art. 70/06
 $\Phi 65\text{mm}$ $\delta \neq 2$



Art. 70/02
H.76xL.170mm



Art. 70/07
 $\Phi 65\text{mm}$ $\delta \neq 2$



Art. 70/03
H.76xL.172mm



Art. 70/08
 $\Phi 65\text{mm}$ $\delta \neq 2$



Art. 70/04
H.90xL.110mm











Art. 70/09
 $\Phi 50\text{mm}$ $\delta \neq 2$

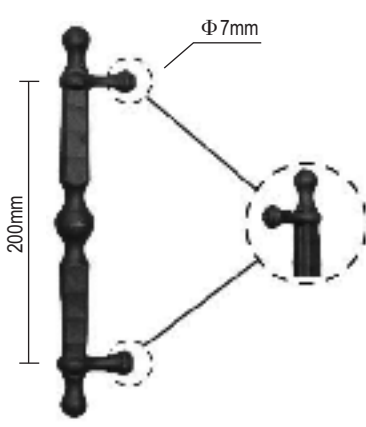
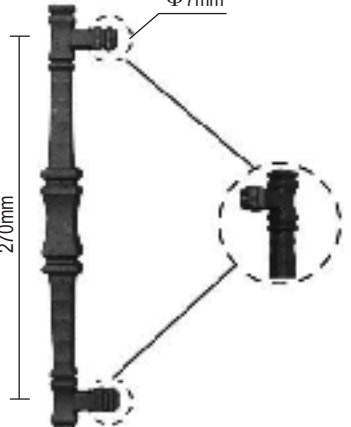
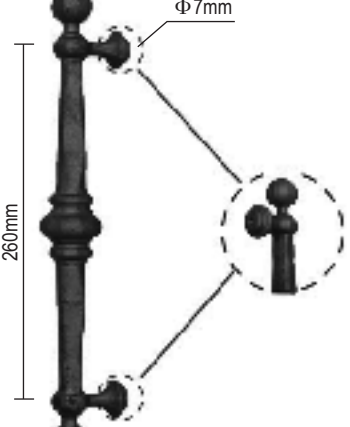

Art. 70/05
H.90xL.110mm









Art. 70/10
 $\Phi 50\text{mm}$ $\delta \neq 2$











 <p>Art. 71/01</p> <p>H.280mm Φ20mm</p>	 <p>Art. 71/02</p> <p>H.320mm \square30mm</p>	 <p>Art. 71/03</p> <p>H.350mm Φ30mm</p>	
 <p>Art. 71/04</p> <p>H.340xL.105mm</p>	 <p>Art. 71/05</p> <p>H.340xL.105mm</p>	 <p>Art. 71/06</p> <p>H.330xL.85mm</p>	 <p>Art. 71/10</p> <p>H.510xL.90mm</p>
 <p>Art. 71/07</p> <p>H.355xL.75mm</p>	 <p>Art. 71/08</p> <p>H.420xL.80mm</p>	 <p>Art. 71/09</p> <p>H.405xL.170mm δ =5</p>	

<p>Art. 72/01 Φ40xH.100mm</p>	<p>Art. 72/02 H.60xL.195mm δ ≠ 3.5</p>	<p>Art. 72/03 H.290xL.150mm δ =4.5</p>	<p>Art. 72/04 H.325xL.99mm δ =5</p>	
<p>Art. 72/05 H.405xL.170mm δ ≠ 5</p>	<p>Art. 72/06 H.340xL.110mm □40mm</p>	<p>Art. 72/07 H.610xL.120mm Φ 12mm</p>	<p>Art. 72/08 H.610xL.130mm Φ 14mm</p>	<p>Art. 72/09 H.610xL.130mm Φ 16mm</p>
<p>Art. 72/10 Φ 21.6xH.39.5mm</p>	<p>Art. 72/11 Φ 20.5xH.40mm</p>	<p>Art. 72/14 H.48xL.81.5mm M 20</p>		
<p>Art. 72/12 Φ 20xH.39mm</p>	<p>Art. 72/13 Φ 21xH.39mm</p>	<p>Art. 72/15 H.48xL.81.5mm M 20</p>		

	<p>Art. 73/01A $\Phi 40 \times H120 \text{mm}$ Art. 73/01B $\Phi 35 \times H120 \text{mm}$ Art. 73/01C $\Phi 30 \times H100 \text{mm}$ Art. 73/01D $\Phi 27 \times H90 \text{mm}$</p>	<p>Art. 73/01E $\Phi 24 \times H80 \text{mm}$ Art. 73/01F $\Phi 20 \times H70 \text{mm}$</p>
	<p>Art. 73/02A $\Phi 40 \times H120 \text{mm}$ Art. 73/02B $\Phi 35 \times H120 \text{mm}$ Art. 73/02C $\Phi 30 \times H100 \text{mm}$ Art. 73/02D $\Phi 27 \times H90 \text{mm}$</p>	<p>Art. 73/02E $\Phi 24 \times H80 \text{mm}$ Art. 73/02F $\Phi 20 \times H70 \text{mm}$ Art. 73/02G $\Phi 16 \times H65 \text{mm}$ Art. 73/02H $\Phi 12 \times H60 \text{mm}$</p>
	<p>Art. 73/03A $\Phi 35 \times H195 \text{mm}$ Art. 73/03B $\Phi 27 \times H145 \text{mm}$</p>	

Item#		Steel Size	Length	Steel Photo
Art. 90/01	A	12X12mm	3000mm	<input type="checkbox"/> SMOOTH SQUARE BAR 
	B	1/2"X1/2"	3000mm	
	C	14X14mm	3000mm	
	D	16X16mm	3000mm	
	E	18X18mm	3000mm	
	F	20X20mm	3000mm	
	G	25X25mm	3000mm	
Art. 90/02	A	12X12mm	3000mm	<input type="checkbox"/> HAMMERED EDGES SQUARE BAR 
	B	1/2"X1/2"	3000mm	
	C	14X14mm	3000mm	
	D	16X16mm	3000mm	
	E	18X18mm	3000mm	
	F	20X20mm	3000mm	
	G	25X25mm	3000mm	
Art. 90/03	A	12X12mm	3000mm	<input type="checkbox"/> FULLY TWISTED SQUARE BAR 
	B	1/2"X1/2"	3000mm	
	C	14X14mm	3000mm	
	D	16X16mm	3000mm	
	E	18X18mm	3000mm	
	F	20X20mm	3000mm	
	G	25X25mm	3000mm	
Art. 90/04	A	12X12mm	3000mm	<input type="checkbox"/> 4-SIDE & 4-EDGE HAMMERED SQUARE BAR 
	B	1/2"X1/2"	3000mm	
	C	14X14mm	3000mm	
	D	16X16mm	3000mm	
	E	18X18mm	3000mm	
	F	20X20mm	3000mm	
	G	25X25mm	3000mm	
Art. 90/05	A	12X12mm	3000mm	<input type="checkbox"/> 4-SIDE GROOVED SQUARE BAR 
	B	1/2"X1/2"	3000mm	
	C	14X14mm	3000mm	
	D	16X16mm	3000mm	
Art. 90/06	A	12X12mm	3000mm	<input type="checkbox"/> 
	B	14X14mm	3000mm	
	C	16X16mm	3000mm	
	D	20X20mm	3000mm	
	E	25X25mm	3000mm	
Art. 90/07	A	12X12mm	3000mm	<input type="checkbox"/> 
	B	14X14mm	3000mm	
	C	16X16mm	3000mm	
	D	20X20mm	3000mm	
	E	25X25mm	3000mm	

Item#		Steel Size	Length	Steel Photo
Art. 91/01	A	12X12mm	3000mm	
	B	1/2"X1/2"	3000mm	
	C	14X14mm	3000mm	
	D	16X16mm	3000mm	
Art. 91/02	A	12X12mm	3000mm	
	B	20X20mm	3000mm	
Art. 91/03	A	12X12mm	3000mm	
	B	14X14mm	3000mm	
	C	16X16mm	3000mm	
	D	20X20mm	3000mm	
	E	25X25mm	3000mm	
Art. 91/04	A	Φ 12mm	3000mm	 ● SMOOTH ROUND BAR
	B	Φ 14mm	3000mm	
	C	Φ 16mm	3000mm	
	D	Φ 18mm	3000mm	
	E	Φ 20mm	3000mm	
	F	Φ 25mm	3000mm	
Art. 91/05	A	Φ 12mm	3000mm	 ● HAMMERED ROUND BAR
	B	Φ 14mm	3000mm	
	C	Φ 16mm	3000mm	
	D	Φ 18mm	3000mm	
	E	Φ 20mm	3000mm	
	F	Φ 25mm	3000mm	
Art. 91/06	A	Φ 12mm	3000mm	 ● TREE BRANCH ROUND BAR
	B	Φ 14mm	3000mm	
	C	Φ 16mm	3000mm	
	D	Φ 18mm	3000mm	
	E	Φ 20mm	3000mm	
Art. 91/07	A	Φ 12mm	3000mm	 ● TREE BARK ROUND BAR
	B	Φ 14mm	3000mm	
	C	Φ 16mm	3000mm	
	D	Φ 18mm	3000mm	
	E	Φ 20mm	3000mm	

Item#		Steel Size	Length	Steel Photo
Art. 92/01	A	Φ 16mm	3000mm	 <p>⊗ FULLY TWISTED ROUND BAR</p>
	B	Φ 20mm	3000mm	
	C	Φ 25mm	3000mm	
	D	Φ 30mm	3000mm	
Art. 92/02	A	12X6mm	3000mm	 
	B	14X5mm	3000mm	
	C	14X6mm	3000mm	
	D	16X6mm	3000mm	
	E	16X8mm	3000mm	
	F	20X6mm	3000mm	
	G	25X6mm	3000mm	
	H	25X8mm	3000mm	
	I	30X6mm	3000mm	
	J	30X8mm	3000mm	
	K	40X8mm	3000mm	
	L	50X8mm	3000mm	
Art. 92/03	A	25X6mm	3000mm	 
	B	30X6mm	3000mm	
	C	30X8mm	3000mm	
	D	40X8mm	3000mm	
	E	50X8mm	3000mm	
Art. 92/04	A	12X6mm	3000mm	 <p>4-EDGE HAMMERED FLAT BAR</p> 
	B	14X6mm	3000mm	
	C	16X6mm	3000mm	
	D	16X8mm	3000mm	
	E	20X6mm	3000mm	
	F	25X6mm	3000mm	
	G	25X8mm	3000mm	
	H	30X6mm	3000mm	
	I	30X8mm	3000mm	
	J	40X8mm	3000mm	
	K	50X8mm	3000mm	
Art. 92/05	A	12X6mm	3000mm	 
	B	14X6mm	3000mm	
	C	16X6mm	3000mm	
	D	16X8mm	3000mm	
	E	25X6mm	3000mm	
	F	30X6mm	3000mm	
	G	30X8mm	3000mm	
	H	40X8mm	3000mm	
Art. 92/06	A	40X6mm	3000mm	 
	B	40X8mm	3000mm	
	C	50X8mm	3000mm	

Item#		Steel Size	Length	Steel Photo
Art. 93/01	A	40X6mm	3000mm	
	B	40X8mm	3000mm	
	C	50X8mm	3000mm	
Art. 93/02		50X16mm	3000mm	
Art. 93/03	A	30X8mm	3000mm	
	B	40X8mm	3000mm	
	C	50X8mm	3000mm	
Art. 93/04	A	40X4mm	3000mm	
	B	40X6mm	3000mm	
	C	40X8mm	3000mm	
Art. 93/05	A	30X6mm	3000mm	
	B	40X8mm	3000mm	
Art. 93/06	A	30X6mm	3000mm	
	B	40X8mm	3000mm	
Art. 93/07		48X15mm	3000mm	
Art. 93/08	A	42X12mm	3000mm	
	B	58X21mm	3000mm	
Art. 93/09	A	30X15mm	3000mm	
	B	40X20mm	3000mm	
Art. 93/10	A	Φ 21mm	3000mm	
	B	Φ 33mm	3000mm	
	C	Φ 48mm	3000mm	
	D	Φ 58mm	3000mm	

Item#		Fits Over	D	Steel size	Length
Art. 94/01	A	Φ 12mm	125mm	30x8mm	3000mm
	B	Φ 12mm	125mm	40x8mm	3000mm
	C	Φ 14mm	125mm	30x8mm	3000mm
	D	Φ 14mm	125mm	40x8mm	3000mm
	E	Φ 16mm	125mm	30x8mm	3000mm
	F	Φ 16mm	125mm	40x8mm	3000mm

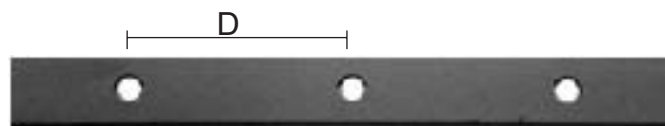

Item#		Fits Over	D	Steel size	Length
Art. 94/02	A	Φ 12mm	125mm	30x8mm	3000mm
	B	Φ 12mm	125mm	40x8mm	3000mm
	C	Φ 14mm	125mm	30x8mm	3000mm
	D	Φ 14mm	125mm	40x8mm	3000mm
	E	Φ 16mm	125mm	30x8mm	3000mm
	F	Φ 16mm	125mm	40x8mm	3000mm

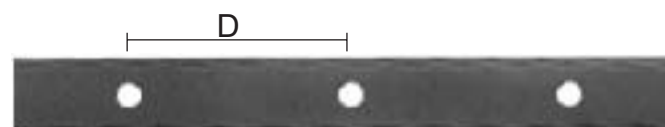

Item#		Fits Over	D	Steel size	Length
Art. 94/03	A	□ 12mm	125mm	30x8mm	3000mm
	B	□ 12mm	125mm	40x8mm	3000mm
	C	□ 14mm	125mm	30x8mm	3000mm
	D	□ 14mm	125mm	40x8mm	3000mm
	E	□ 16mm	125mm	30x8mm	3000mm
	F	□ 16mm	125mm	40x8mm	3000mm

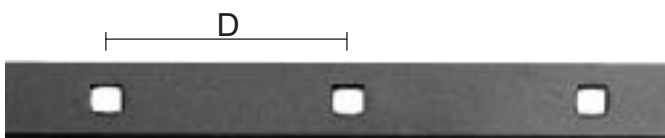

Item#		Fits Over	D	Steel size	Length
Art. 94/04	A	□ 12mm	125mm	30x8mm	3000mm
	B	□ 12mm	125mm	40x8mm	3000mm
	C	□ 14mm	125mm	30x8mm	3000mm
	D	□ 14mm	125mm	40x8mm	3000mm
	E	□ 16mm	125mm	30x8mm	3000mm
	F	□ 16mm	125mm	40x8mm	3000mm

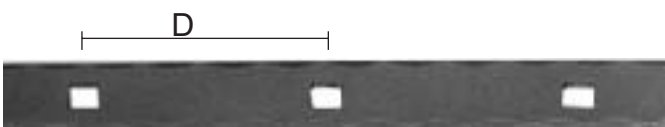

Item#		Fits Over	D	Steel size	Length
Art. 95/01	A	◇ 12mm	125mm	30x8mm	3000mm
	B	◇ 12mm	125mm	40x8mm	3000mm
	C	◇ 14mm	125mm	30x8mm	3000mm
	D	◇ 14mm	125mm	40x8mm	3000mm
	E	◇ 16mm	125mm	30x8mm	3000mm
	F	◇ 16mm	125mm	40x8mm	3000mm

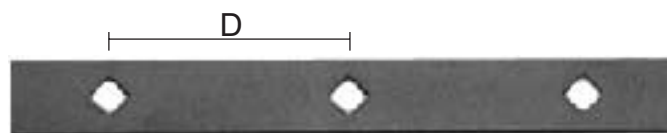

Item#		Fits Over	D	Steel size	Length
Art. 95/02	A	◇ 12mm	125mm	30x8mm	3000mm
	B	◇ 12mm	125mm	40x8mm	3000mm
	C	◇ 14mm	125mm	30x8mm	3000mm
	D	◇ 14mm	125mm	40x8mm	3000mm
	E	◇ 16mm	125mm	30x8mm	3000mm
	F	◇ 16mm	125mm	40x8mm	3000mm

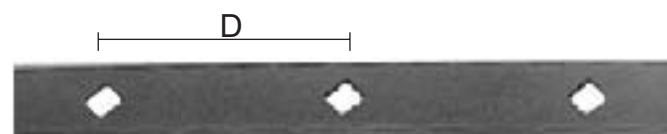

Item#		D	Steel size	Length
Art. 95/03		125mm	30x6mm	2000mm

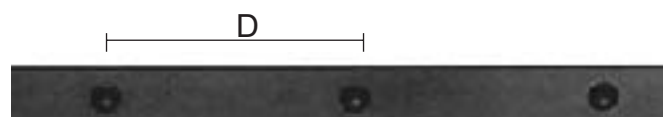

Item#		D	Steel size	Length
Art. 95/04		125mm	30x6mm	2000mm

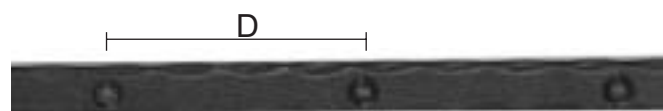

Item#		Fits Over	D	Steel size	Length
Art. 95/05	A	Φ 14mm	140mm	Φ 14mm	2000mm
	B	Φ 16mm	150mm	Φ 16mm	2000mm
	C	Φ 18mm	160mm	Φ 18mm	2000mm
	D	Φ 20mm	170mm	Φ 20mm	2000mm

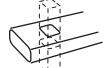

Item#		Steel size	Thickness	Size Of Hole	D	Length
		mm	mm	mm	mm	mm
Art. 96/01	Art. 96/01A	25x25	1.5	13	101.25	3000
Art. 96/02	Art. 96/02A	30x30	1.5	16.3	103.2	3000
Art. 96/03	Art. 96/03A	30x30	1.5	16.3	116	3000
Art. 96/04	Art. 96/04A	40x40	1.5	16.3	103.2	3000
Art. 96/05	Art. 96/05A	40x40	1.5	16.3	116	3000
Art. 96/06	Art. 96/06A	40x40	1.5	19.4	103.2	3000
Art. 96/07	Art. 96/07A	40x40	1.5	19.4	116	3000
Art. 96/08	Art. 96/08A	50x50	1.5	16.3	103.2	3000
Art. 96/09	Art. 96/09A	50x50	1.5	16.3	116	3000
Art. 96/10	Art. 96/10A	50x50	1.5	19.4	103.2	3000
Art. 96/11	Art. 96/11A	50x50	1.5	19.4	116	3000
Art. 96/12	Art. 96/12A	50x50	1.5	25.4	103.2	3000
Art. 96/13	Art. 96/13A	50x50	1.5	25.4	116	3000
Art. 96/14	Art. 96/14A	30x50	1.5	16.3	103.2	3000
Art. 96/15	Art. 96/15A	30x50	1.5	16.3	116	3000
Art. 96/16	Art. 96/16A	30x50	1.5	19.4	103.2	3000
Art. 96/17	Art. 96/17A	30x50	1.5	19.4	116	3000
Art. 96/18	Art. 96/18A	25x50	1.5	16.3	103.2	3000
Art. 96/19	Art. 96/19A	25x50	1.5	16.3	116	3000
Art. 96/20	Art. 96/20A	25x50	1.5	19.4	103.2	3000
Art. 96/21	Art. 96/21A	25x50	1.5	19.4	116	3000
Art. 96/22	Art. 96/22A	25x40	1.5	16.3	103.2	3000
Art. 96/23	Art. 96/23A	25x40	1.5	16.3	116	3000
Art. 96/24	Art. 96/24A	25x40	1.5	19.4	103.2	3000
Art. 96/25	Art. 96/25A	20x40	1.5	19.4	116	3000
Art. 96/26	Art. 96/26A	20x40	1.5	16.3	103.2	3000
Art. 96/27	Art. 96/27A	20x40	1.5	16.3	116	3000
Art. 96/28	Art. 96/28A	20x40	1.5	19.4	103.2	3000
Art. 96/29	Art. 96/29A	20x40	1.5	19.4	116	3000

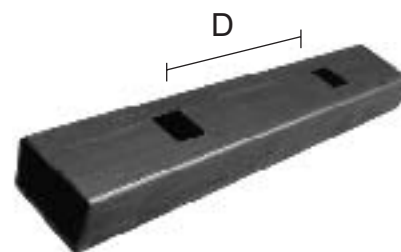
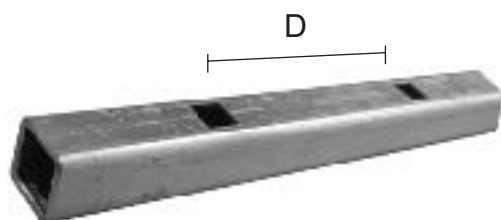

Item#	Steel Size	Thickness	Length	Steel Photo	
Art. 97/01	A	20X20mm	2mm	3000mm	
	B	25X25mm	2mm	3000mm	
	C	30X30mm	2mm	3000mm	
	D	40X40mm	2mm	3000mm	
	E	50X50mm	2mm	3000mm	
	F	60X60mm	2mm	3000mm	
	G	80X80mm	2mm	3000mm	
	H	100X100mm	2mm	3000mm	
	I	30X20mm	2mm	3000mm	
	J	40X20mm	2mm	3000mm	
	K	40X30mm	2mm	3000mm	
	L	50X30mm	2mm	3000mm	
	M	60X40mm	2mm	3000mm	



H



H

	□12mm	□14mm		□12mm	□14mm
H.170mm	Art. 97/02A	Art. 97/02B	H.170mm	Art. 97/11A	Art. 97/11B
H.500mm	Art. 97/03A	Art. 97/03B	H.500mm	Art. 97/12A	Art. 97/12B
H.600mm	Art. 97/04A	Art. 97/04B	H.600mm	Art. 97/13A	Art. 97/13B
H.700mm	Art. 97/05A	Art. 97/05B	H.700mm	Art. 97/14A	Art. 97/14B
H.800mm	Art. 97/06A	Art. 97/06B	H.800mm	Art. 97/15A	Art. 97/15B
H.900mm	Art. 97/07A	Art. 97/07B	H.900mm	Art. 97/16A	Art. 97/16B
H.1000mm	Art. 97/08A	Art. 97/08B	H.1000mm	Art. 97/17A	Art. 97/17B
H.1100mm	Art. 97/09A	Art. 97/09B	H.1100mm	Art. 97/18A	Art. 97/18B
H.1200mm	Art. 97/10A	Art. 97/10B	H.1200mm	Art. 97/19A	Art. 97/19B